

APPLICATION NOTE 29

Testing Capacitors with High DC Bias

This application note will describe the process of analysing the impedance of a capacitor when subjected to high DC bias voltages. This particular application required impedance analysis of a 1 μ F capacitor, upon which a 0~48V DC bias voltage would also be applied. A typical application for this test is the analysis of SMPS filter capacitors.

Set Up:

1. PSM1700 Frequency Response Analyzer (PSM3750 recommended for voltages exceeding 48Vrms)
2. LPA400B Power Amplifier
3. HF01A Current Shunt
4. Load (1 μ F capacitor in series with a 1k Ω current limiting resistor)

Schematic:

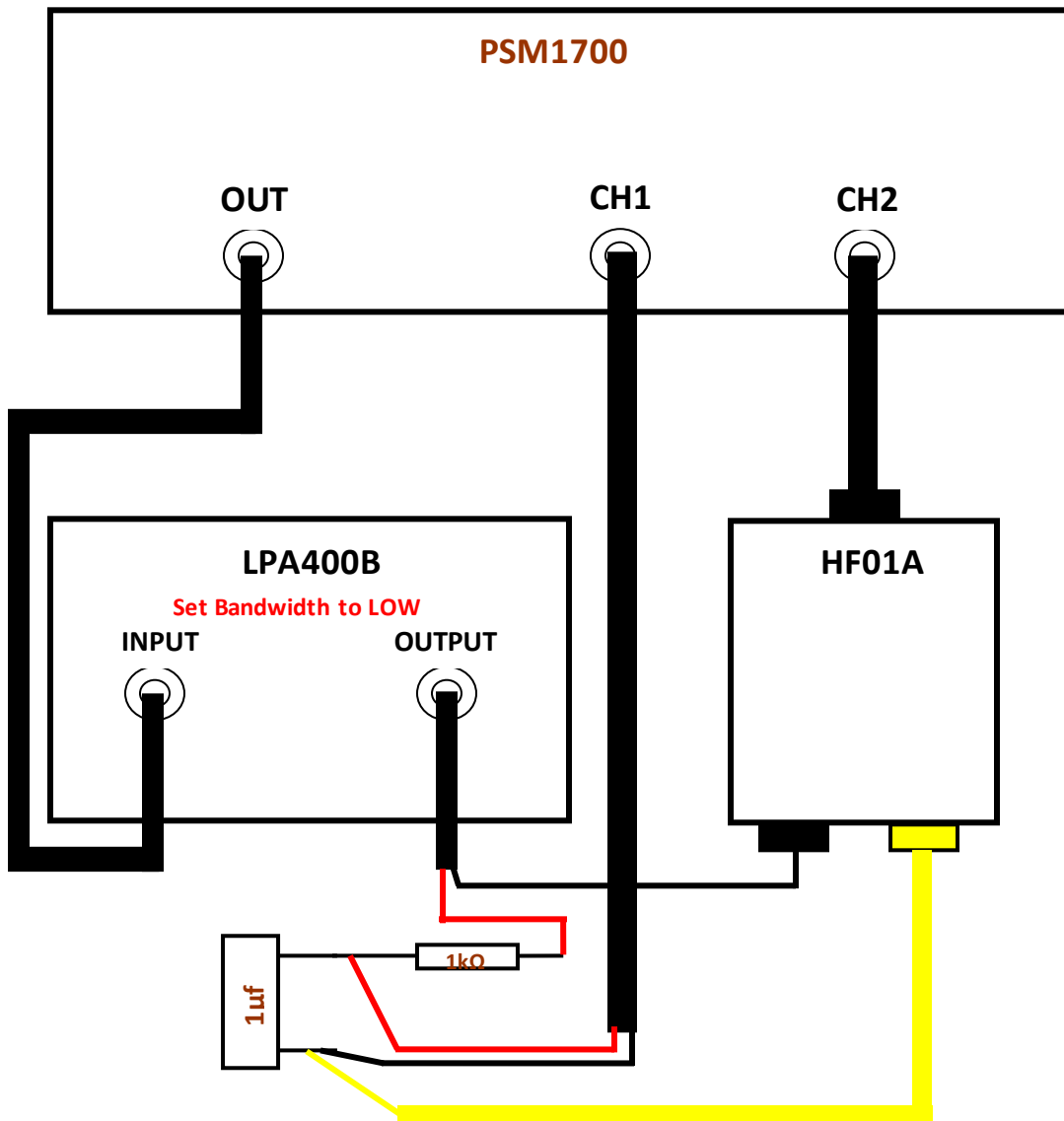

Fig. 1

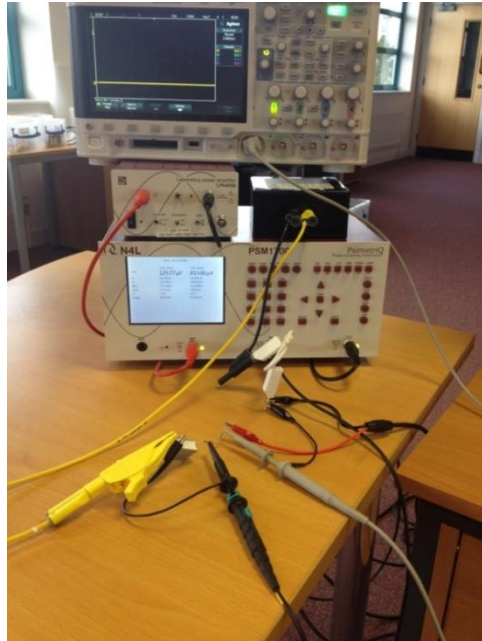

Fig. 2

Note: The Oscilloscope in the picture above is used for the purposes of a visual representation of both the DC offset and the AC injected ripple frequency during the tests. An oscilloscope is not required for this test as the DC and AC components of the injected waveform can be verified more accurately with the PSM1700 "RMS Voltmeter" mode.

LPA400B Settings:

Bandwidth = LOW
 Coupling = AC+DC
 Gain = x50

A resistor of 1kΩ is fitted in series with the 1uF capacitor, this is installed to limit the inrush current in the circuit when the LPA400B is turned on, preventing inadvertent tripping of the amplifier protection circuit.

Test Configuration

Output and CH1 screens will change as the test sequences are progressed, Ch2 - which is used to measure the current through the circuit will stay constant, settings for the external shunt are shown below.

INPUT 2	
input 2	external shunt
minimum range	10mV
autoranging	full autorange
coupling	ac+dc
scale factor	-1.0000
external shunt	1.0000 Ω

Fig. 3

A shunt value of 1Ω is set, as per the HF01A shunt datasheet.

Test 1:

AC signal set to 50mV x 50 gain = 2.5V

DC offset set to 0V

Ripple frequency set to 1 kHz

It is important to remember that it is the ripple frequency that is used to analyze the capacitance of the test device. This is performed via a DFT (Discrete Fourier Analysis) technique, which extracts the magnitudes and phases of the voltage and current at the injected ripple frequency, from which the impedance is calculated.

PSM1700 Output and CH1 display settings

Note: All LCR screenshots taken will illustrate the corresponding results at each Frequency and DC offset point, with the coupling set on CH1 to ac+dc and ac only

OUTPUT OPTIONS	
amplitude	50.000mVpk
ceiling	10.000Vpk
frequency	1.00000k Hz
offset	+000.00mV
waveform	sinewave
amplitude step	1.1000 times
frequency step	2.00000 times
output	on

Fig. 4

INPUT 1	
input 1	voltage input
minimum range	10mV
autoranging	full autorange
coupling	ac+dc
scale factor	+1.0000

Fig. 5

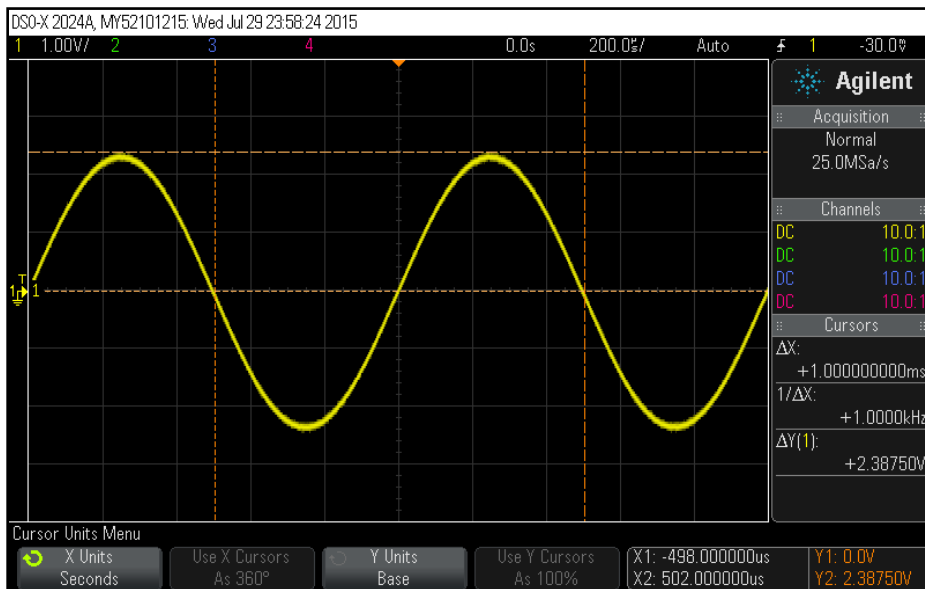

Fig. 6

Oscilloscope image showing the AC ripple frequency, no DC offset.

LCR Meter screenshot displaying the capacitance measurement of the 1 μ F capacitor under test conditions

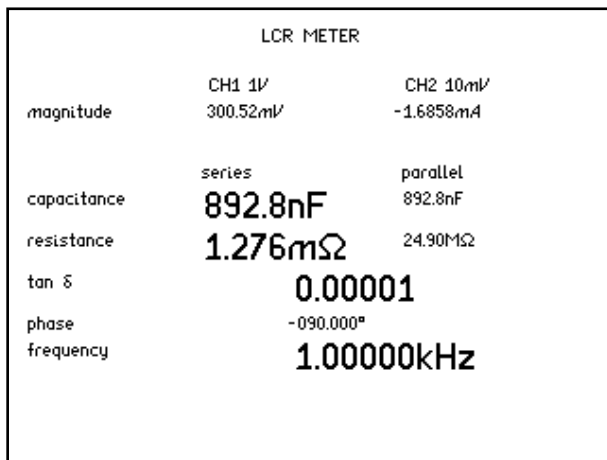

Fig. 7
Coupling = ac+dc

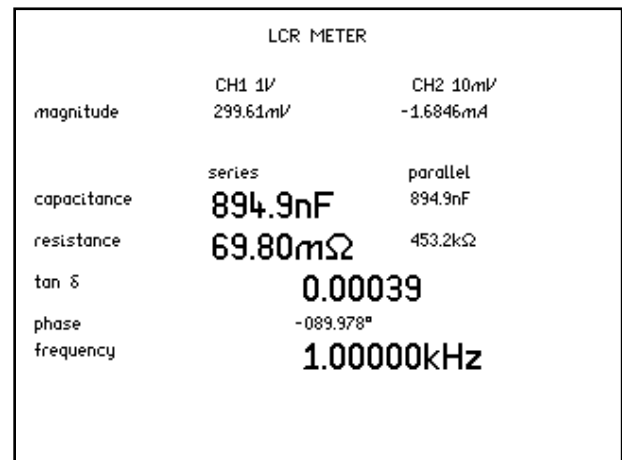

Fig. 8
Coupling = ac only

NOTE: You will notice from Fig.7 above that the magnitude of the AC signal across the load measures 300.52mV and therefore the PSM1700 instrument which is set to full autorange for CH1 has selected the 1V range for both AC and AC+DC coupling configurations. Once an offset is applied, it is good practice to AC couple the measurement inputs (after verification of the DC signal level) as this will allow the instrument to range upon the AC signal only, instead of the DC signal. Thus, facilitating high accuracy through lower range errors, as well as more stable results.

Test 2:

AC signal set to 50mV x 50 gain = 2.5V
 DC offset set to 0V
 Ripple Frequency set to 10 kHz

LCR Meter displays the capacitance measurement in both coupling modes with the frequency set to 10 kHz

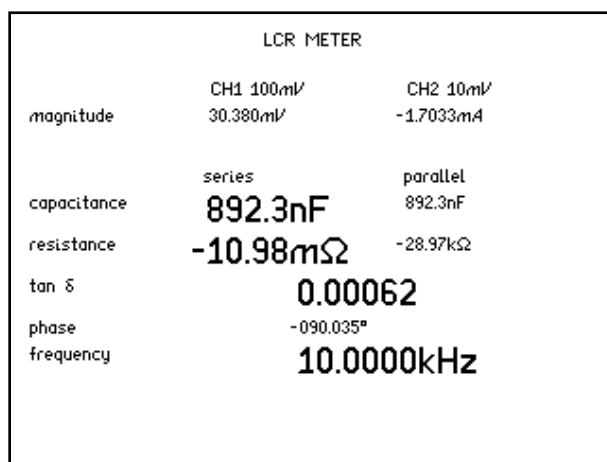

Fig. 9
Coupling = ac+dc

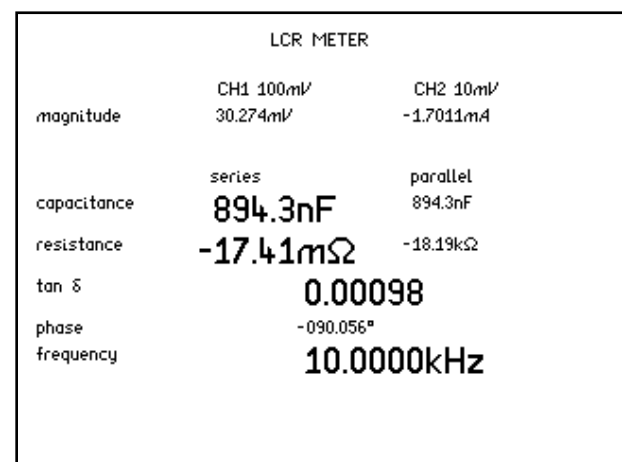

Fig. 10
Coupling = ac only

Again note that the PSM1700 has auto ranged on CH1 to the 100mV range as the measured voltage across the load is now 30.3mV

Test 3:

AC signal set to 50mV x 50 gain = 2.5V
 DC offset set to 0V
 Ripple frequency set to 100 kHz

LCR Meter displays the capacitance measurement in both coupling modes with the frequency set to 100 kHz

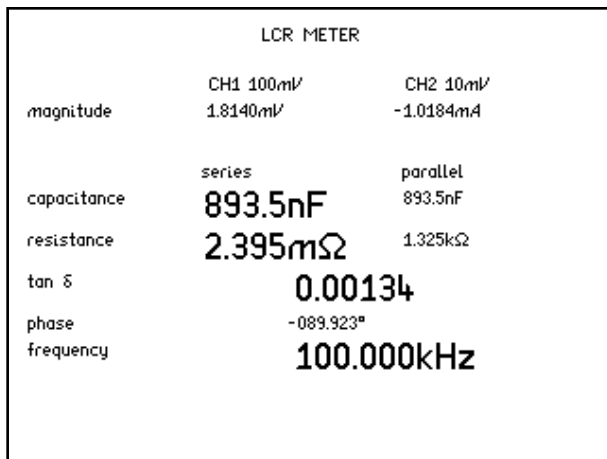

Fig. 11
 Coupling = ac+dc

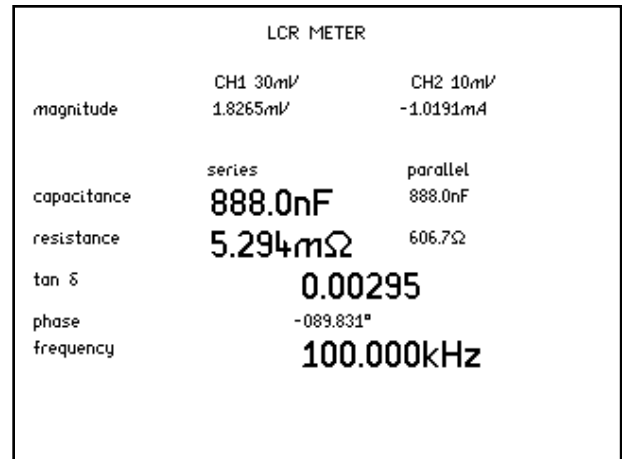

Fig. 12
 Coupling = ac only

Test 4:

AC signal set to 50mV x 50 gain = 2.5V
 DC offset set to 10V
 Ripple frequency set to 1 kHz

Output adjusted for a DC offset of 200 mV x50 gain = 10V

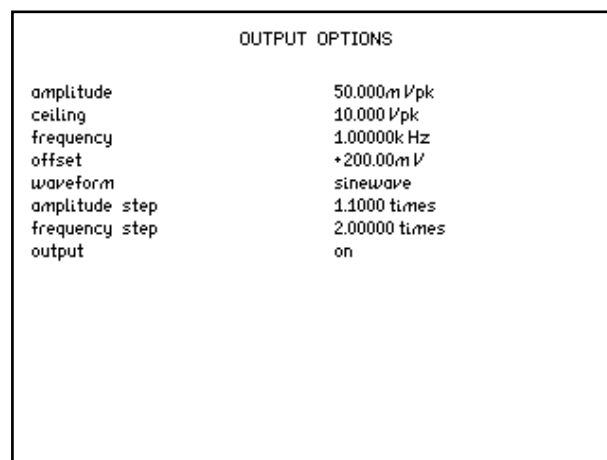
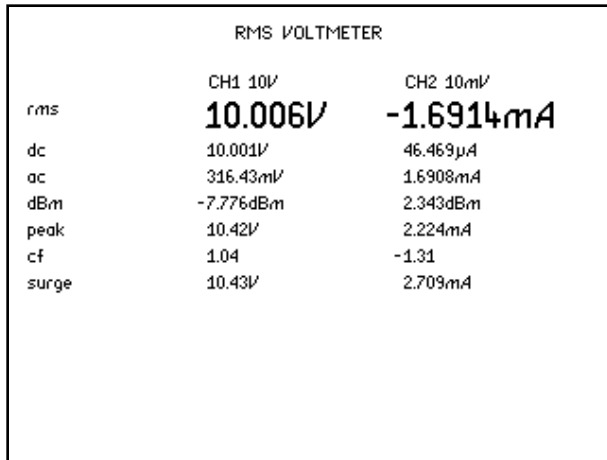

Fig. 13

RMS Mode display



The PSM1700 RMS display measures a 10V dc offset along with the ac ripple voltage.

Fig. 14

Oscilloscope display showing ripple frequency on top the DC signal, 1 kHz AC and 10V DC offset.

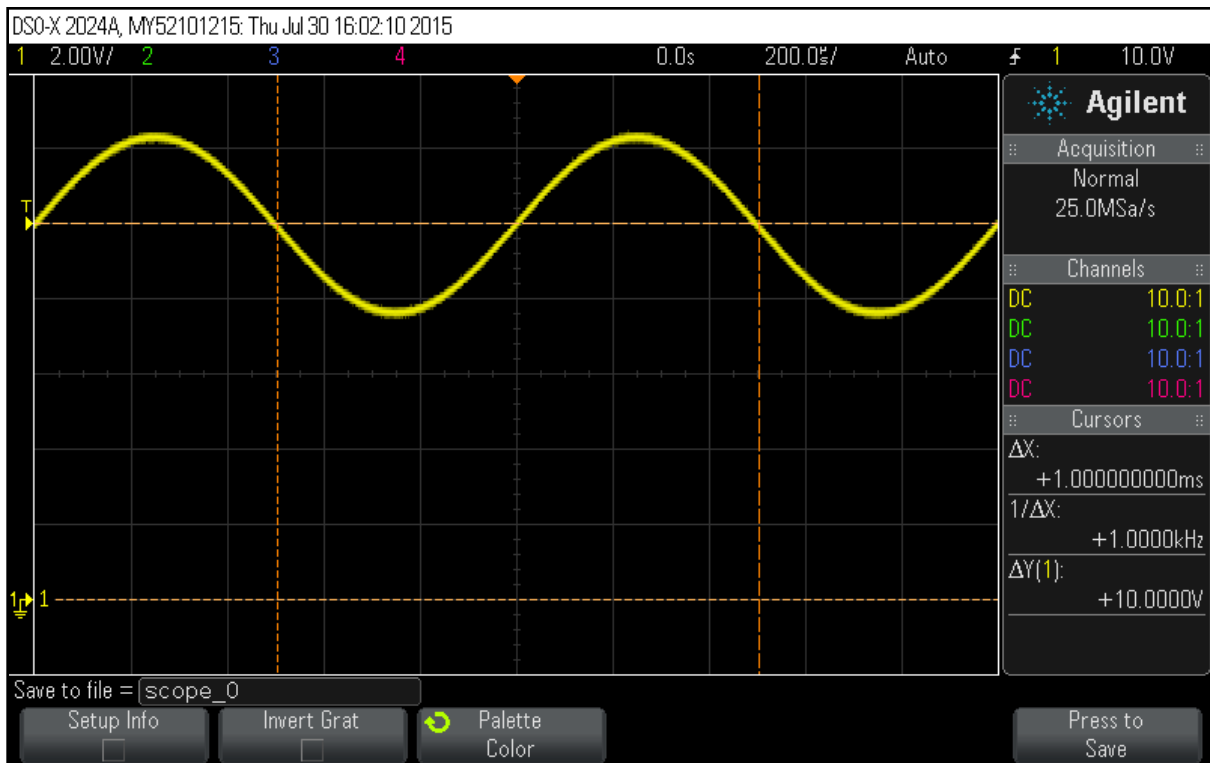

Fig. 15

LCR Meter displays the capacitance measurement in both coupling modes with the frequency set to 1 kHz

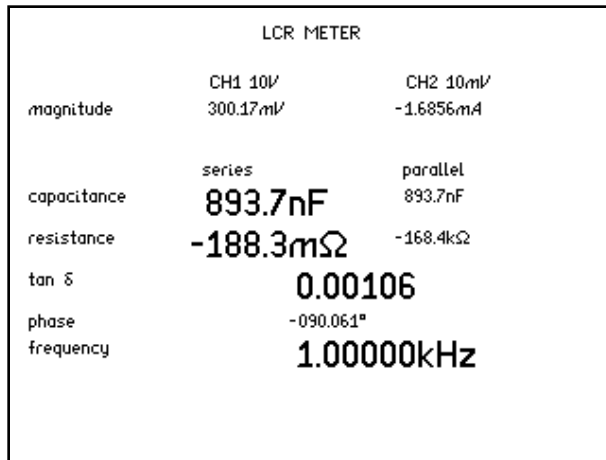

Fig. 16
Coupling = ac+dc

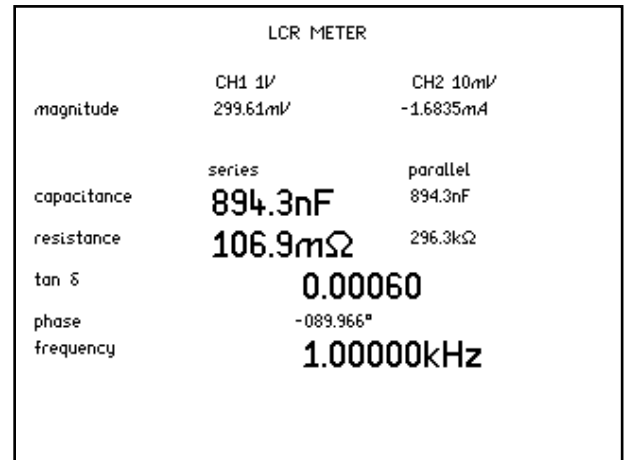

Fig. 17
Coupling = ac only

Test 5:

AC signal set to 50mV x 50 gain = 2.5V

DC offset set to 10V

Ripple frequency set to 10 kHz

LCR Meter displays the capacitance measurement in both coupling modes with the frequency set to 10 kHz

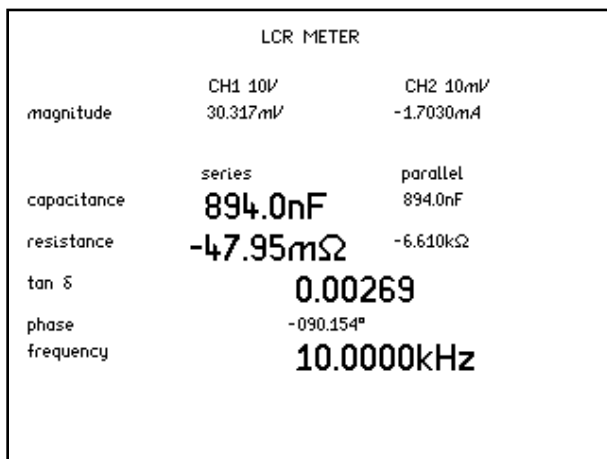

Fig. 18
Coupling = ac+dc

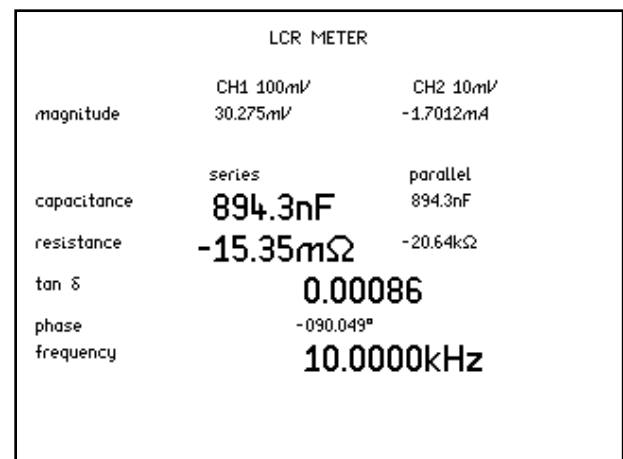

Fig. 19
Coupling = ac only

Test 6

AC signal set to 50mV x 50 gain = 2.5V
 DC offset set to 10V
 Ripple frequency set to 100 kHz

LCR Meter displays the capacitance measurement in both coupling modes with the frequency set to 100 kHz

LCR METER		
	CH1 10V	CH2 10mV
magnitude	2.0588mV	-1.0188mV
capacitance	series 795.6nF	parallel 779.7nF
resistance	-286.2mΩ	-14.27Ω
tan δ	0.14307	
phase	-098.142°	
frequency	100.000kHz	

Fig. 20
Coupling = ac+dc

LCR METER		
	CH1 30mV	CH2 10mV
magnitude	1.8257mV	-1.0189mV
capacitance	series 888.2nF	parallel 888.2nF
resistance	6.420mΩ	500.1Ω
tan δ	0.00358	
phase	-089.795°	
frequency	100.000kHz	

Fig. 21
Coupling = ac only

This test illustrates the issue when AC+DC coupling, it is noticeable that the capacitance value is not the same in both modes. It is advisable to only use AC coupling for impedance measurements with high voltage DC bias.

Test 7:

AC signal set to 50mV x 50 gain = 2.5V
 DC offset set to 48V
 Ripple frequency set to 1 kHz

Output adjusted to achieve a DC offset of 960 mV x 50 gain = 48V

OUTPUT OPTIONS	
amplitude	50.000m Vpk
ceiling	10.000 Vpk
frequency	1.00000k Hz
offset	+960.00mV
waveform	sinewave
amplitude step	1.1000 times
frequency step	2.00000 times
output	on

Fig. 22

RMS Mode

Screenshots below are taken with CH1 coupling set to ac+dc and ac only. Note how the PSM1700, set to autorange in CH1 ranges to suit the appropriate input signal

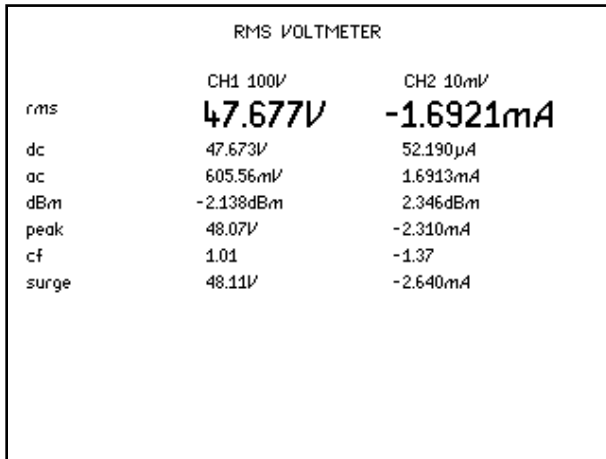

Fig. 23
Coupling set to ac+dc

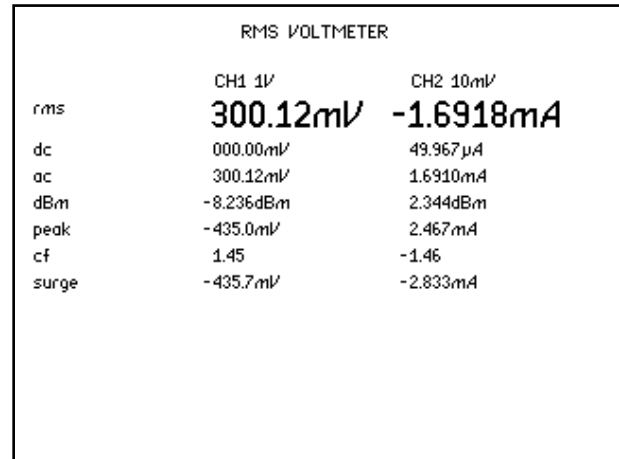

Fig. 24
Coupling set to ac only

Oscilloscope display showing ripple frequency at 1 kHz and dc offset to be 48V

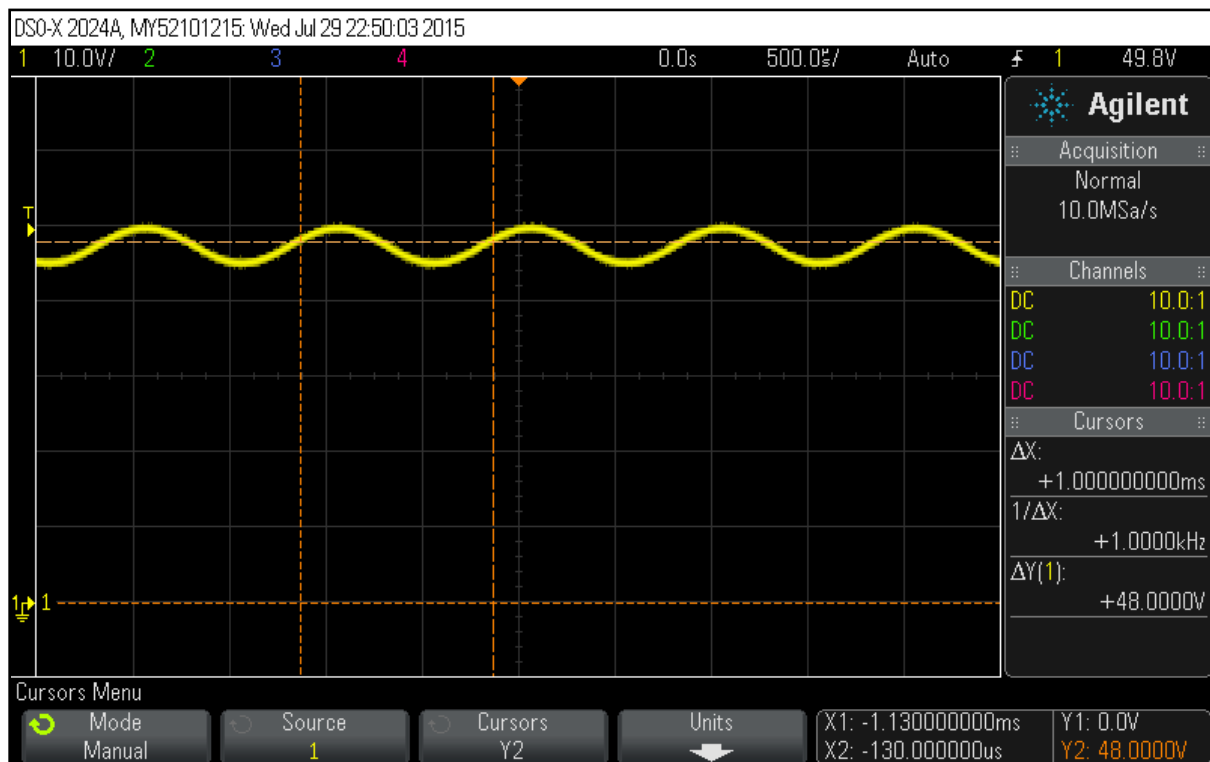

Fig. 25

LCR Meter displays the capacitance measurement in both coupling modes with the frequency set to 1 kHz

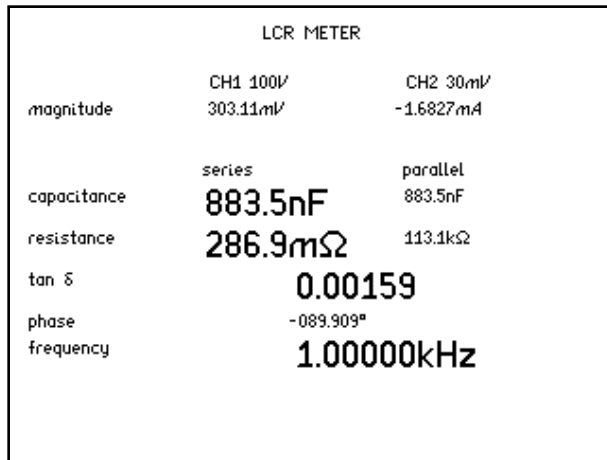

Fig. 26
Coupling = ac+dc

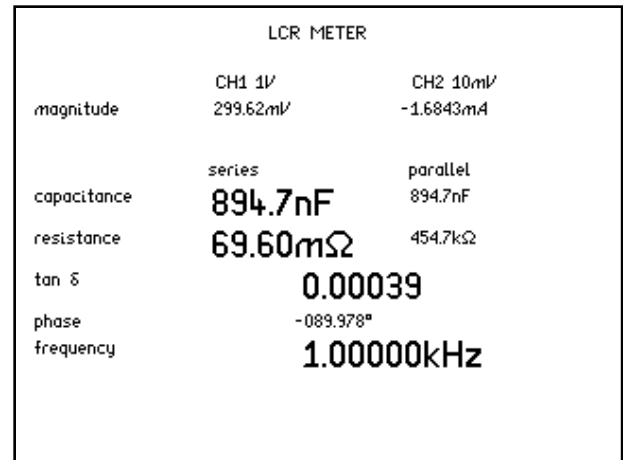

Fig. 27
Coupling = ac only

Note: When AC+DC coupling is selected, channel 1 ranges to the 100V range due to the 48V DC offset present. It is recommended that AC coupling is selected, so that the CH1 input will range to the AC ripple frequency component.

Test 8:

AC signal set to 50mV x 50 gain = 2.5V
 DC offset set to 48V
 Ripple frequency set to 10 kHz

LCR Meter displays the capacitance measurement in both coupling modes with the frequency set to 10 kHz

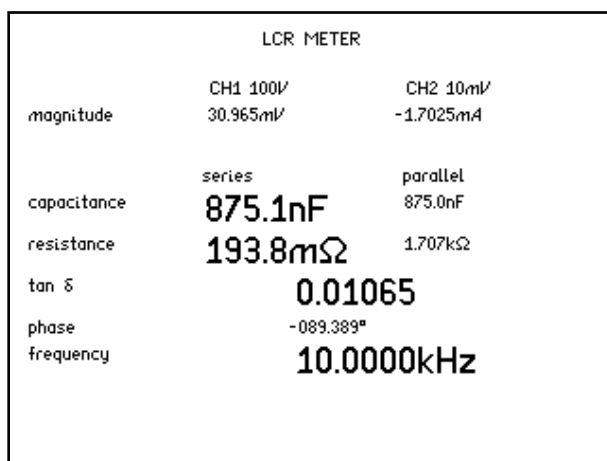

Fig. 27
Coupling = ac+dc

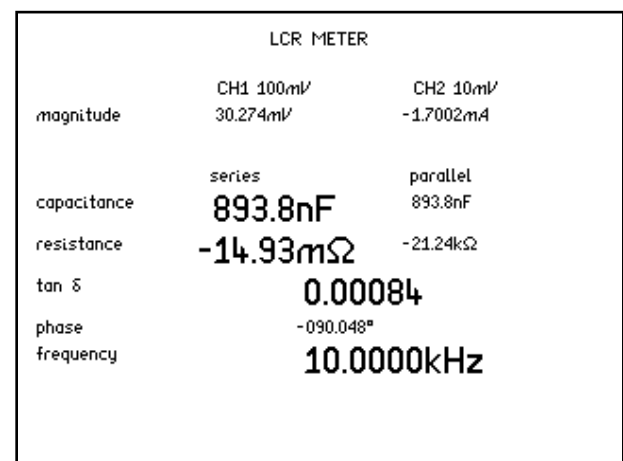

Fig. 27
Coupling = ac only

Test 9:

AC signal set to 50mV x 50 gain = 2.5V
 DC offset set to 48V
 Ripple frequency set to 100 kHz

LCR Meter displays the capacitance measurement in both coupling modes with the frequency set to 100 kHz

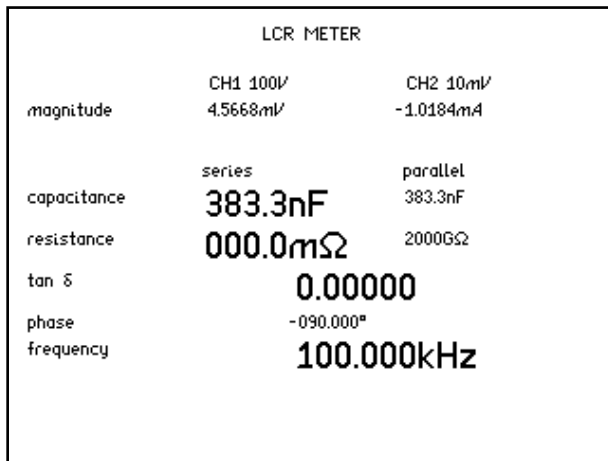

Fig. 28
 Coupling = ac+dc

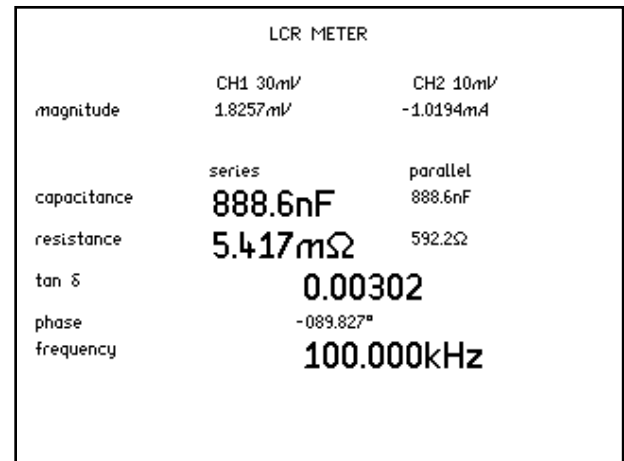

Fig. 29
 Coupling = ac only

Test Results:
High DC Bias Voltage / Capacitor Tests

Notes: PSM1700 AC amplitude = 50.00mVpk
 LPA400B set to x 50, AC Output Signal of 2.5Vpk

DC offset	Frequency	Capacitance measurements with coupling set to ac+dc	Capacitance measurements with coupling set to ac only
0V	1kHz	892.8nF	894.4nF
0V	10kHz	892.3nF	894.3nF
0V	100kHz	893.5nF	888.0nF
10V	1kHz	893.7nF	894.3nF
10V	10kHz	894.0nF	894.3nF
10V	100kHz	795.6nF	888.2nF
48V	1kHz	883.5nF	894.7nF
48V	10kHz	875.1nF	893.8nF
48V	100kHz	383.3nF	888.6nF

DC Bias Voltage >50V, measurement approach

The maximum RMS Input voltage that can be applied to the input channels of the PSM1700 is 50Vrms, there is also a 100Vpk limit between the chassis ground and the measurement input. This 100Vpk capability can be utilised to achieve bias voltages of greater than 50V with the use of x10 attenuating probes and an innovative connection technique called "divider Zx low".

Example 100Vdc bias voltage requirement;

Using the same capacitor and the same test equipment as in the previous tests, with the addition of x10 attenuators. A Capacitance measurement of a filter capacitor with >50V DC bias applied was carried out.

Schematic:

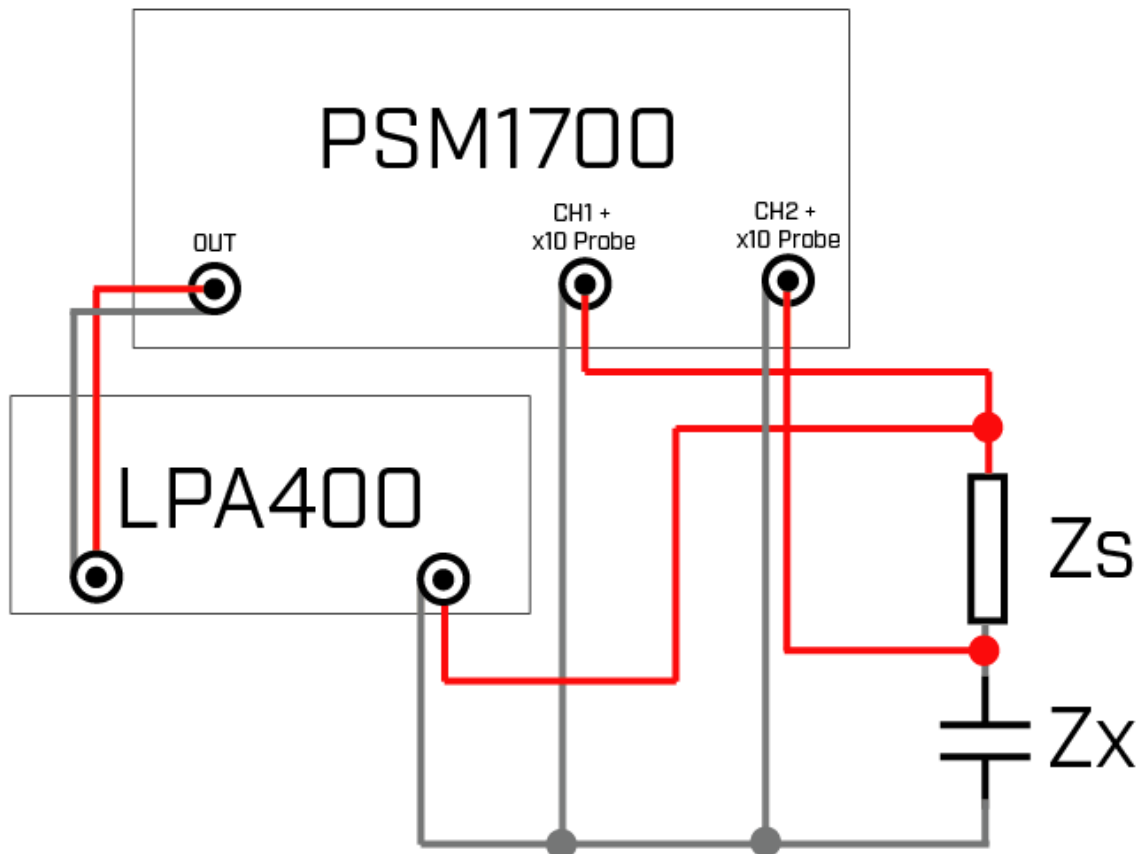

Additional settings:

CH1: Input 1 : Voltage input, Coupling AC, Scale Factor +10.000

CH2: Input 2 : External Shunt, Coupling AC, Scale Factor +100.00m

External Shunt: 1k Ω

LCR Menu: connection - divider Zx low

Probe Trimming

It may be necessary to trim the x10 oscilloscope probes, especially if the results are not as expected. To do so, follow section 9.1 of the PSM1700 user guide.

Results

High DC Bias Voltage (above 50V DC) / Capacitor Tests

DC offset	Frequency	Capacitance measurements with coupling set to ac only
70V	1kHz	877.1nF
70V	10kHz	856.9nF
70V	100kHz	663.4.0nF
100V	1kHz	881.3nF
100V	10kHz	856.1.8nF
100V	100kHz	664.6nF

Summary

This application note has described the use of the N4L PSM1700 and the LPA400 Laboratory Power Amplifier for impedance analysis of Capacitors with high Voltage DC bias. As highlighted in the results, it is recommended that engineers make use of AC coupling as this will offer more stable results when measurements are taken in the presence of high DC bias, facilitated by more suitable range selection of the input channel.

The PSM3750 is an ideal option for impedance measurements above 50Vrms, the PSM3750 will directly measure up to 500Vpk.