

APPLICATION NOTE 33 Battery Cell Electrochemical Impedance Spectroscopy N4L PSM3750 Impedance Analyzer + BATT470m Current Shunt
--

Introduction

The field of electrochemical impedance spectroscopy (EIS) has been active for many years, yet it is only recently that EIS has become popular for both research and development as well as various preventative maintenance fields. EIS combines the field of Chemistry with Electrical engineering, the crossover can sometimes expose engineers and scientists to technical terms and instrumentation they do not commonly encounter. This application note discusses a measurement approach utilising N4L instrumentation which provides impedance measurements of a range of batteries/cells, from Lithium-Ion to Hydrogen fuel.

Why do we perform EIS?

Several important characteristics can be determined from an EIS measurement. For example, during rapid dynamic loading of vehicle battery cells there will be high frequency transient load events occurring at the terminals of the battery, causing pulsating DC current through the battery. There are various electrochemical effects including oxidant starvation, temperature and more, one effect is capacitance within the battery which is formed through the effects of a short charge zone between electrode and electrolyte. This is known as the double layer capacitor effect. This capacitance will lie in parallel with the electrochemical charge transfer reaction because it is on the electrodes surface.[1]

Determination of the characteristics of the battery represented as an electrical equivalent circuit are important to both the battery designer and the power system development engineer. This will assist engineers who are modelling the response of a system to loading effects, such modelling can be performed with PSMComm2 software, available free of charge with all N4L instrumentation.

Initially within this application note, impedance analysis of a number of passive elements/circuits is performed to familiarise the reader with Nyquist representation of a complex circuit. After which, analysis of a Duracell MX1500 is performed utilising a simple connection method including a PSM3750 Frequency Response Analyzer and a BATT470m EIS current shunt.

Impedance measurements are also required in order to characterise the battery at high frequencies. A charging circuit for example, utilising a pulse width modulated charge circuit will require knowledge of the impedance of the battery cell at the charge frequency in order to derive charge rate etc. This can all be derived from accurate EIS measurements of the cell.

Initial Tests and Basic Theory

The impedance of a simple RC combination can be represented in Nyquist form as well as a traditional impedance vs frequency XY plot.

Test Circuit

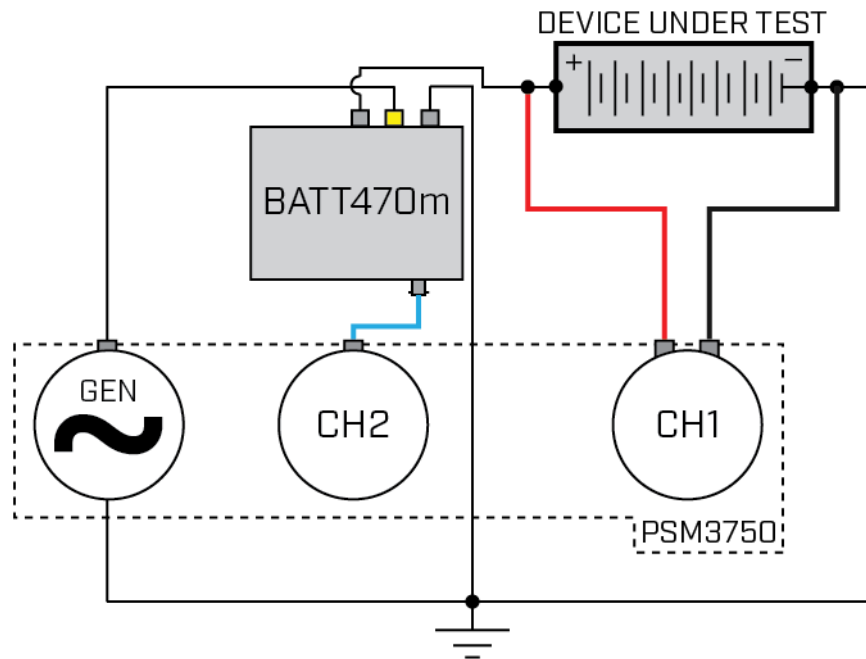

Fig 1.

Instead of a battery, the test circuit we will use to demonstrate EIS includes a 45kΩ resistor and a 10nF capacitor arranged in parallel, an impedance sweep is performed from 1Hz to 200kHz. Initially the impedance of the circuit will be dominated by the resistor as the capacitor is effectively open circuit at 1Hz. This results in an in-phase overall impedance and a phase angle close to 0 degrees.

$$Z_{DUT} = \frac{1}{\sqrt{\left(\frac{1}{R}\right)^2 + \omega C^2}}$$

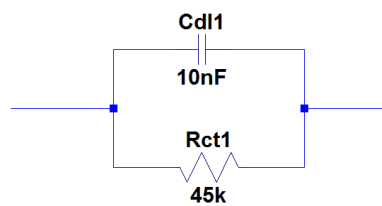

Fig 2.

In practical applications, Cd1 represents the capacitance present between the plate/electrolyte interface created by a double layer of ions within an electrochemical cell. It is this capacitance that will initially supply the bursts of high frequency current when a battery/cell is loaded. Rct is the charge transfer resistance, present due to plate-electrolyte ion transfer limitations.

As the frequency is increased, the capacitor begins to influence the total impedance of the parallel pair to a greater degree and eventually forms a short circuit (nominally) at higher frequencies. The point at which the capacitor will have the greatest effect and subsequently the circuit will exhibit the greatest quadrature impedance, is at the point when then the quadrature impedance of the capacitor equals the in phase impedance of the resistor.

APP033 Battery Cell Electrochemical Impedance Spectroscopy	Issue 1	D000207
Newtons4th Ltd 1 Bede Island Road Leicester LE2 7EA UK	Tel: +44 (0)116 2301066	

This occurs at the following frequency:

$$f_{max} = \frac{1}{2\pi RC}$$

The subsequent phase angle at this frequency will be 45 deg.

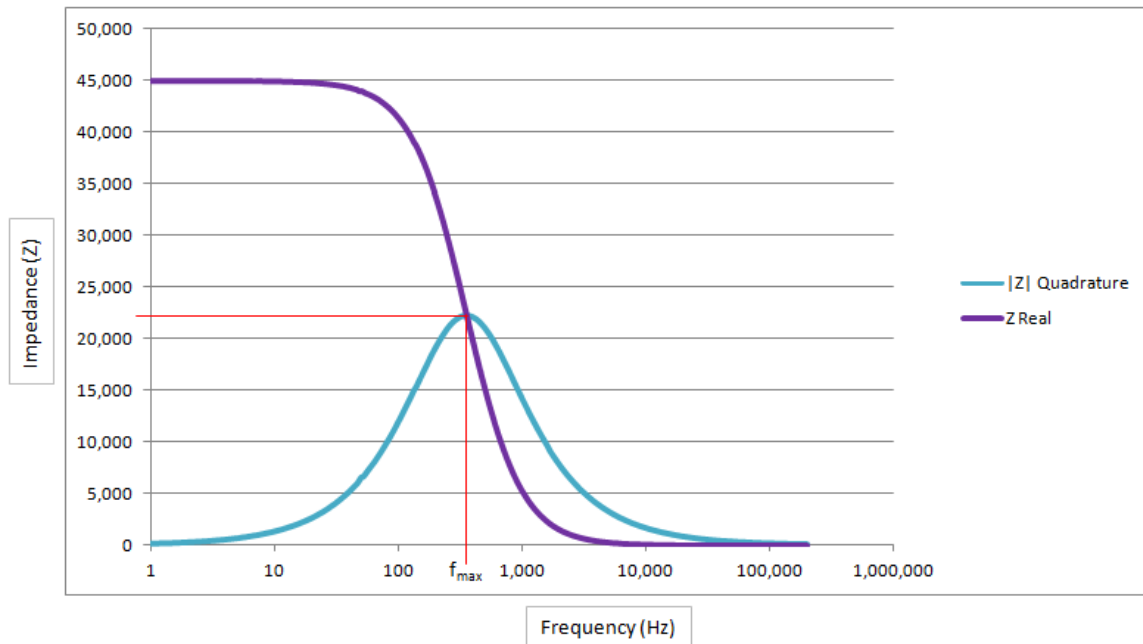

Fig 3. Log Linear Plot

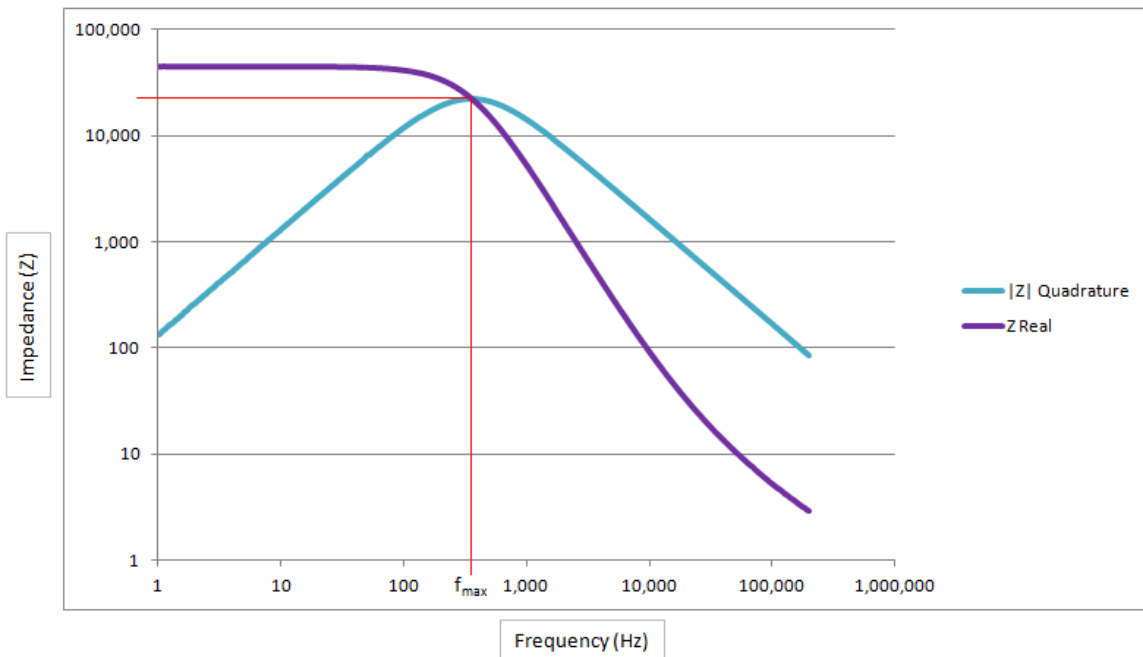

Fig 4. Log Log Plot

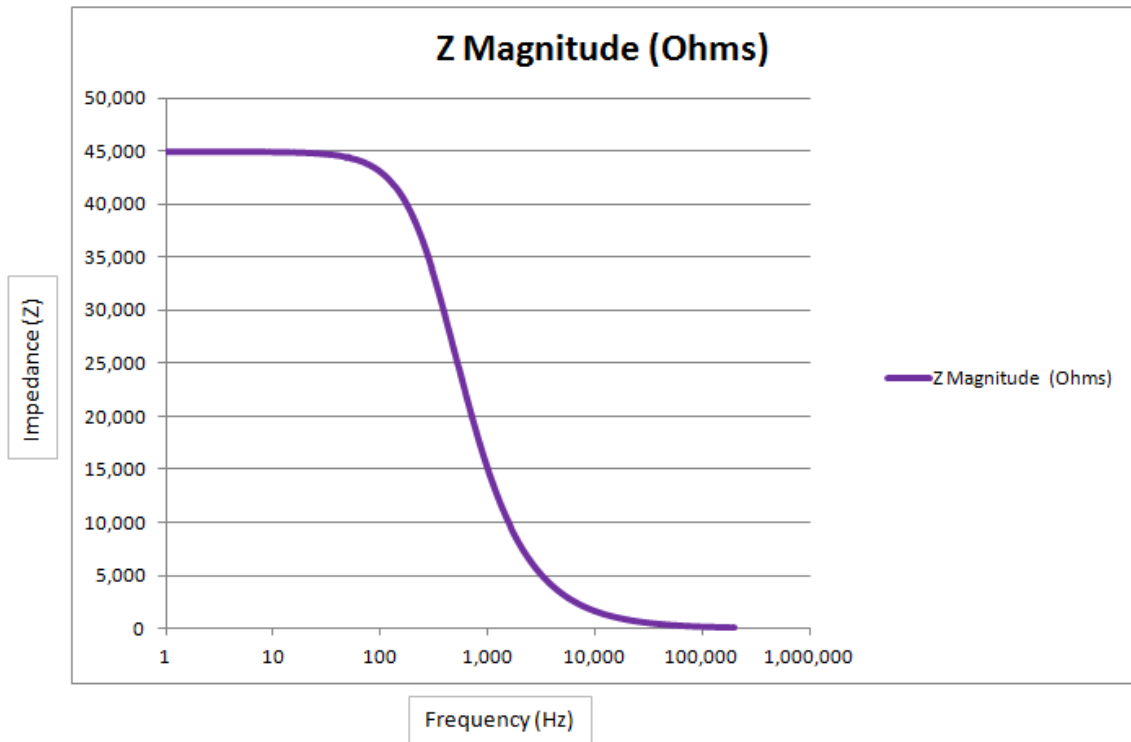

Fig 5. Impedance Plot

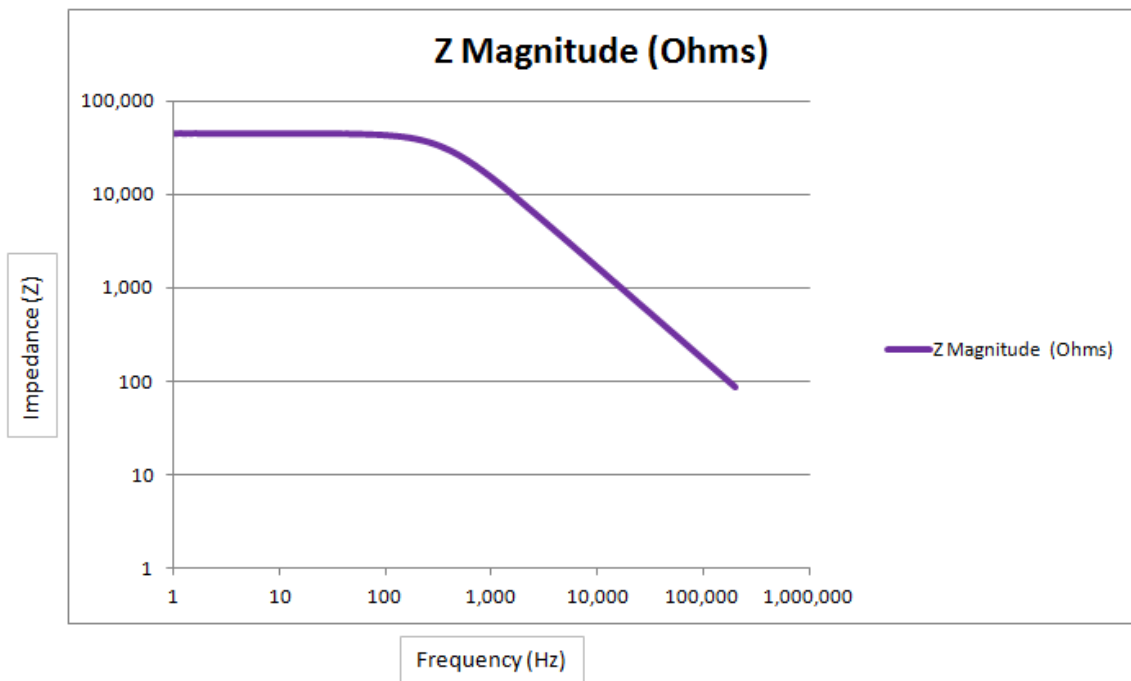

Fig 6. Logarithmic Impedance Plot

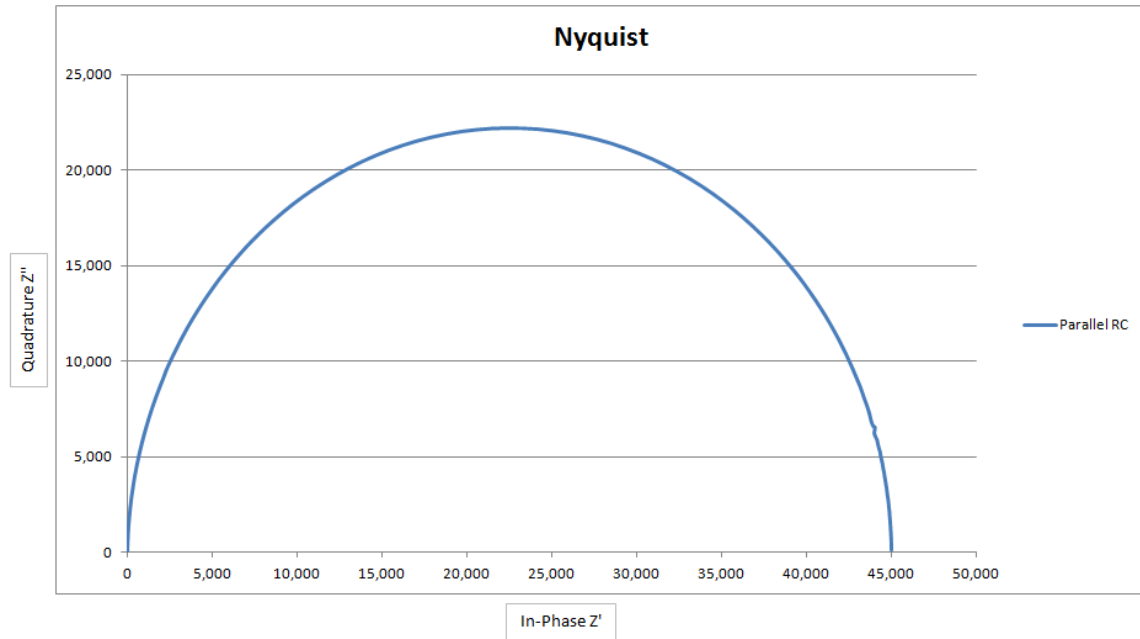

Fig 7.

The Nyquist plot provides a clear picture of the location of the maximum reactive impedance, this point can be used to determine an unknown Cdl value. This method of modeling is used within the Randle cell modeling function in PSMComm2 software.

$$1/(2\pi * f * Z_{max}) = C_{dl}$$

The test circuit was then modified to incorporate a series resistance Rs, this resistance represents the metallic resistance of the plates and the electrolyte resistance.

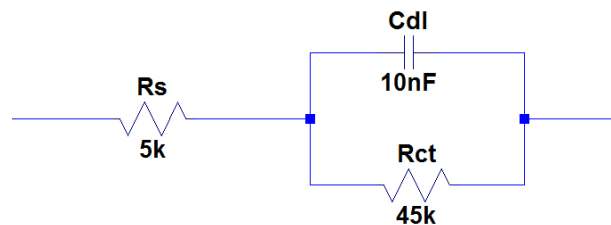

Fig 8. Simplified Randles Cell

At low frequency, the circuit in fig 8. will exhibit a total impedance of 50kOhm, this is due to the fact that the capacitor (Cdl) in parallel with Rct will be effectively open circuit.

Once the capacitor (Cdl) becomes short circuit at high frequency, the circuit will exhibit an impedance of 5kOhms and be predominantly resistive.

The Nyquist plot presents the result clearly, with the same semi-circle in figure 7 (due to the Rct || Cdl combination) being shifted 5kOhms from the origin.

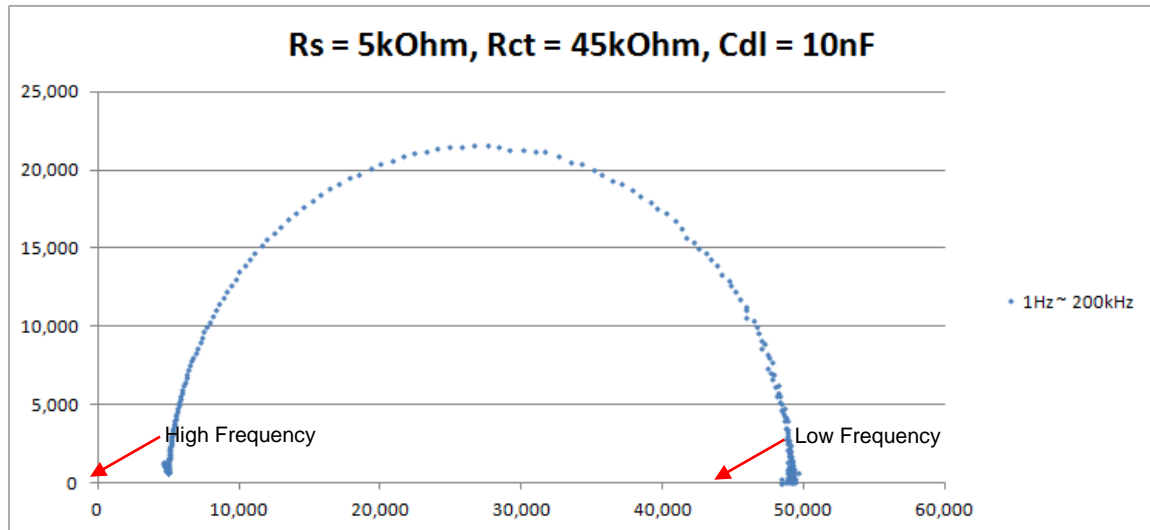

Fig 9.

Fig 9. illustrates the response of the circuit in fig 8. in Nyquist form. The Nyquist plot is shifted on the real axis by 5kOhms. The low frequency end of the plot starts on the real axis at approximately 50kOhms, looping around back to the real axis at 5kOhms at high frequencies.

Warburg Impedance

To complete the Randles cell, an impedance component known as the Warburg Impedance is added to the model. This component cannot be created from discrete components as it is a constant phase element. The Warburg impedance represents common diffusion linear in nature, ie unrestricted diffusion from a planar electrode. The constant phase exhibited by the Warburg diffusion element is 45deg, the impedance magnitude is inversely proportional to the square root of frequency.

$$|Z_w| = \sqrt{2} \frac{A_w}{\sqrt{\omega}}$$

Where A_w is the Warburg coefficient

On a logarithmic plot, the Warburg impedance appears as a straight line with a gradient of $\frac{1}{2}$.

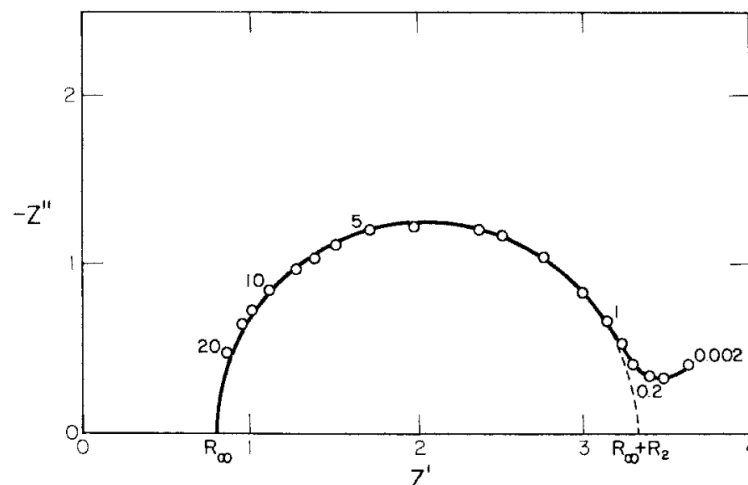

Fig 10. Warburg Impedance (0.2Hz ~ 0.002Hz) [2]

Experiment #1

In this experiment, EIS is performed on a Duracell Ultra Power AA battery. The Duracell specification indicates an impedance of 81mOhm @ 1kHz, this frequency point was checked initially to verify the test setup. An EIS sweep from 100mHz to 5kHz is performed using the test circuit illustrated in Fig 11.b.

Instrumentation

PSM3750-2C
BATT470m
2x EST10m
4mm Connection leads
Oscilloscope probe

Connections

The PSM output generator is connected in series with a DC blocking capacitor of 100uF, the final test circuit then consists of the 1.5V Duracell MX1500 battery in series with the HF470m current shunt.

What is inside the BATT470m?

The BATT470m features a DC blocking capacitor which is charged through a bleed resistor R_{LIMIT} (see Fig 11a), before initial connection the switch next to R_{CHARGE} (SW2) will be closed and SW1 will be opened. This disconnects the PSM generator from the test circuit to ensure that there is not an instantaneous inrush of current into the PSM Generator when a high voltage DUT is connected between A_{LO} and GEN-.

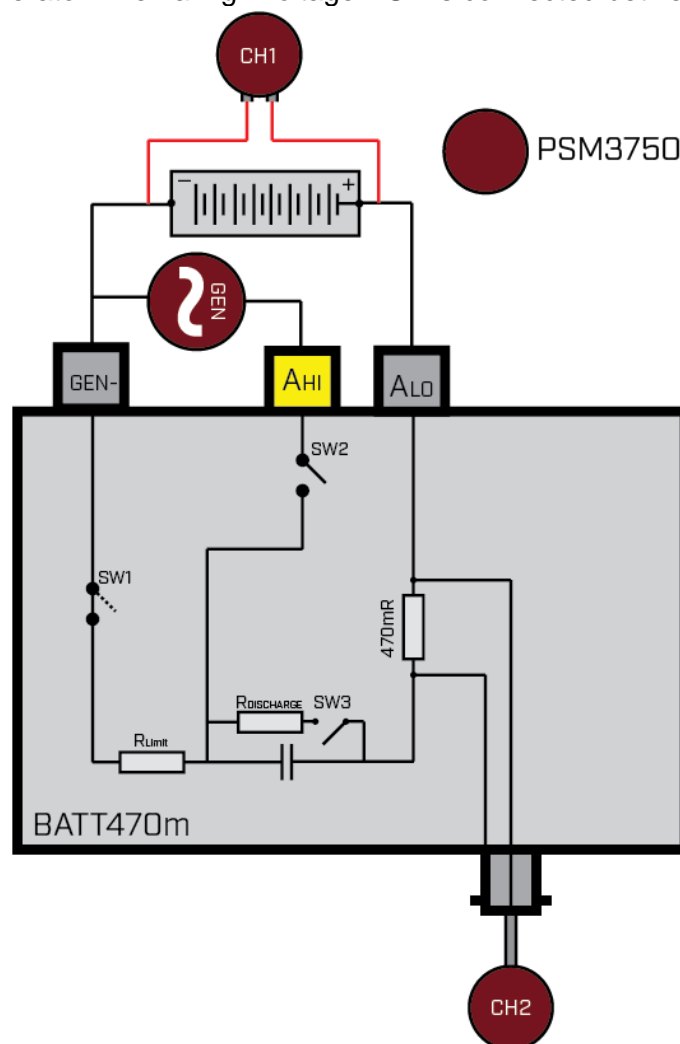
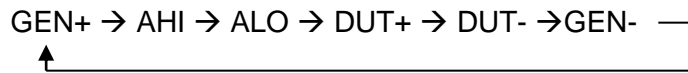

Fig 11.a

APP033 Battery Cell Electrochemical Impedance Spectroscopy	Issue 1	D000207
Newtons4th Ltd 1 Bede Island Road Leicester LE2 7EA UK	Tel: +44 (0)116 2301066	

After 1 minute, the DC blocking capacitor will be fully charged and SW2 can be closed as well as SW1 opened.

Once these switch settings are made (SW1=OPEN, SW2=CLOSED), the generator can then be used to inject AC current through the blocking capacitor and into the DUT. During test, the current path is as follows;



Final test schematic

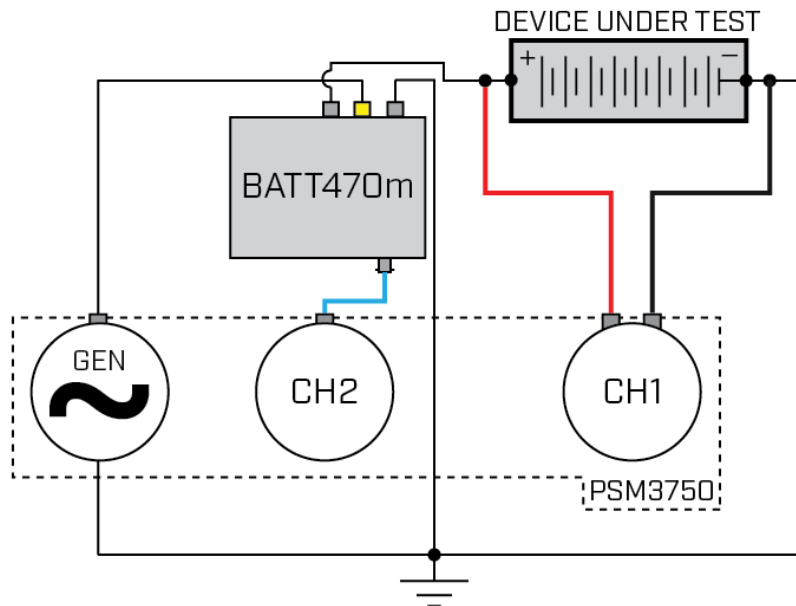



Fig 11.b

The BATT470m in Fig 11.a/b prevents loading the battery through the generator impedance (50R).



Nominal voltage	1.5 V
Impedance	81 m-ohm @ 1 kHz
Typical weight	24 g (0.8 oz)
Typical volume	8.4 cm ³ (0.5 in ³)
Terminals	Flat
Storage temperature range	5°C to 30°C (41°F to 86°F)
Operating temperature range	-20°C to 54°C (-4°F to 130°F)
Designation	IEC: LR6

Fig 12. Battery Specification

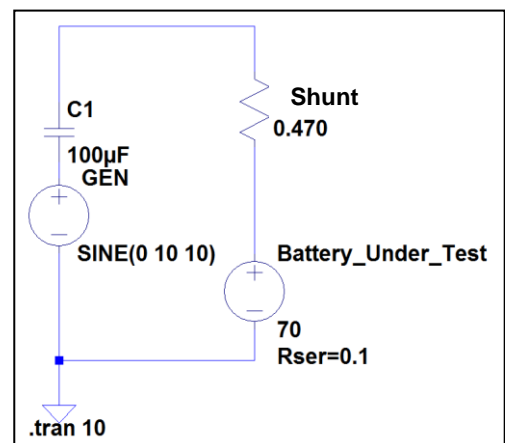

Fig 13. Test Circuit

CH1 of the PSM will measure the voltage drop across the Battery, CH2 is connected across the BATT470m with the supplied isolated BNC cable to measure the current within the test circuit. The PSM3750 then performs a Discrete Fourier transform (DFT) analysis of the applied sinusoid to derive the in-phase and

quadrature components as well as impedance parameters. As the PSM3750 inputs are isolated, they can be connected directly to any test circuit up to 500Vpk.

The PSM3750 generates an AC sinusoidal signal, which passes through the DC blocking BATT470m and the device under test. This signal is then swept over a range of frequencies whilst the PSM3750 simultaneously records the impedance of the battery, the data is plotted on the instrument display as well as exported to PSMComm2 software.

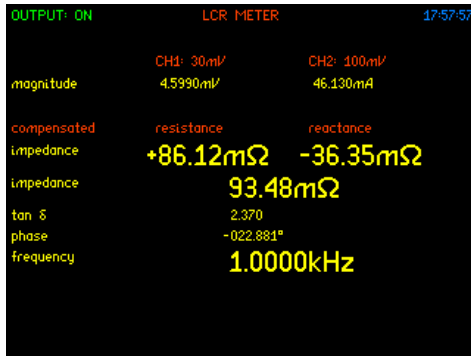

Fig 14.

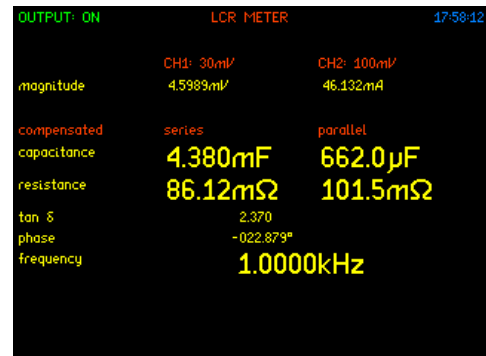

Fig 15.

The PSM3750 recorded a series resistance of 86mOhm, note the reactance value of -36.mOhms, equating to 4.4mF

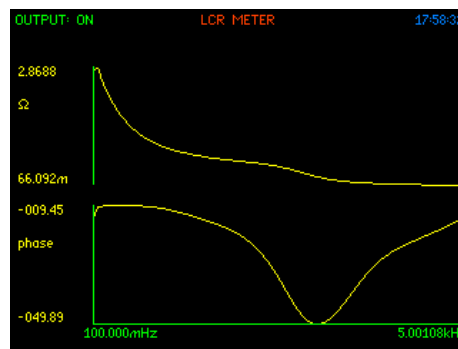



Fig 16. Impedance plot from 0.1Hz to 5kHz

Update January 2019 : Nyquist plotting is now available on the PSM3750, allowing the user to view impedance data in Nyquist format without a PC.



OUTPUT: ON LCR METER 17:58:44

1	100.000mHz	2.7638Ω	-013.378°
2	111.549mHz	2.8688Ω	-010.020°
3	124.432mHz	2.5966Ω	-009.739°
4	138.802mHz	2.3782Ω	-009.628°
5	154.832mHz	2.1954Ω	-009.583°
6	172.714mHz	2.0384Ω	-009.522°
7	192.560mHz	1.8954Ω	-009.506°
8	214.910mHz	1.7648Ω	-009.473°
9	239.730mHz	1.6552Ω	-009.446°
10	267.416mHz	1.5555Ω	-009.490°
11	298.300mHz	1.4660Ω	-009.504°
12	332.750mHz	1.3850Ω	-009.539°
13	371.179mHz	1.3120Ω	-009.594°
14	414.046mHz	1.2468Ω	-009.660°
15	461.864mHz	1.1883Ω	-009.760°
16	515.204mHz	1.1358Ω	-009.862°
17	574.705mHz	1.0893Ω	-009.999°
18	641.077mHz	1.0480Ω	-010.164°
19	715.114mHz	1.0114Ω	-010.350°
20	797.702mHz	979.12mΩ	-010.558°

Fig 17.

Example table of results

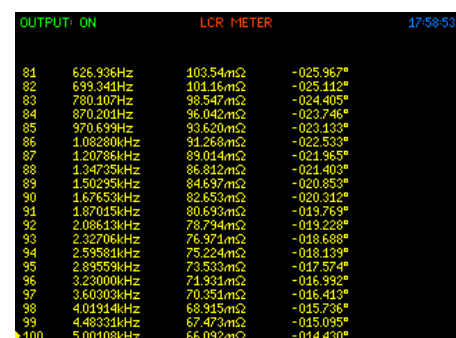

OUTPUT: ON LCR METER 17:58:53

81	626.936Hz	103.54mΩ	-025.967°
82	699.341Hz	101.16mΩ	-025.112°
83	780.107Hz	98.547mΩ	-024.405°
84	870.201Hz	96.042mΩ	-023.746°
85	970.699Hz	93.620mΩ	-023.133°
86	1.08280kHz	91.263mΩ	-022.539°
87	1.20786kHz	89.014mΩ	-021.955°
88	1.34735kHz	86.812mΩ	-021.403°
89	1.50295kHz	84.637mΩ	-020.853°
90	1.67653kHz	82.653mΩ	-020.312°
91	1.87015kHz	80.693mΩ	-019.769°
92	2.08613kHz	78.794mΩ	-019.228°
93	2.32706kHz	76.971mΩ	-018.688°
94	2.59581kHz	75.224mΩ	-018.139°
95	2.89598kHz	73.533mΩ	-017.574°
96	3.23000kHz	71.931mΩ	-016.992°
97	3.60303kHz	70.351mΩ	-016.413°
98	4.01914kHz	68.815mΩ	-015.736°
99	4.48331kHz	67.473mΩ	-015.095°
100	5.00108kHz	66.092mΩ	-014.430°

Fig 18.

All results can be exported to excel or alternatively analysed in N4L's PSMComm2 software.

APP033 Battery Cell Electrochemical Impedance Spectroscopy	Issue 1	D000207
Newtons4th Ltd 1 Bede Island Road Leicester LE2 7EA UK	Tel: +44 (0)116 2301066	

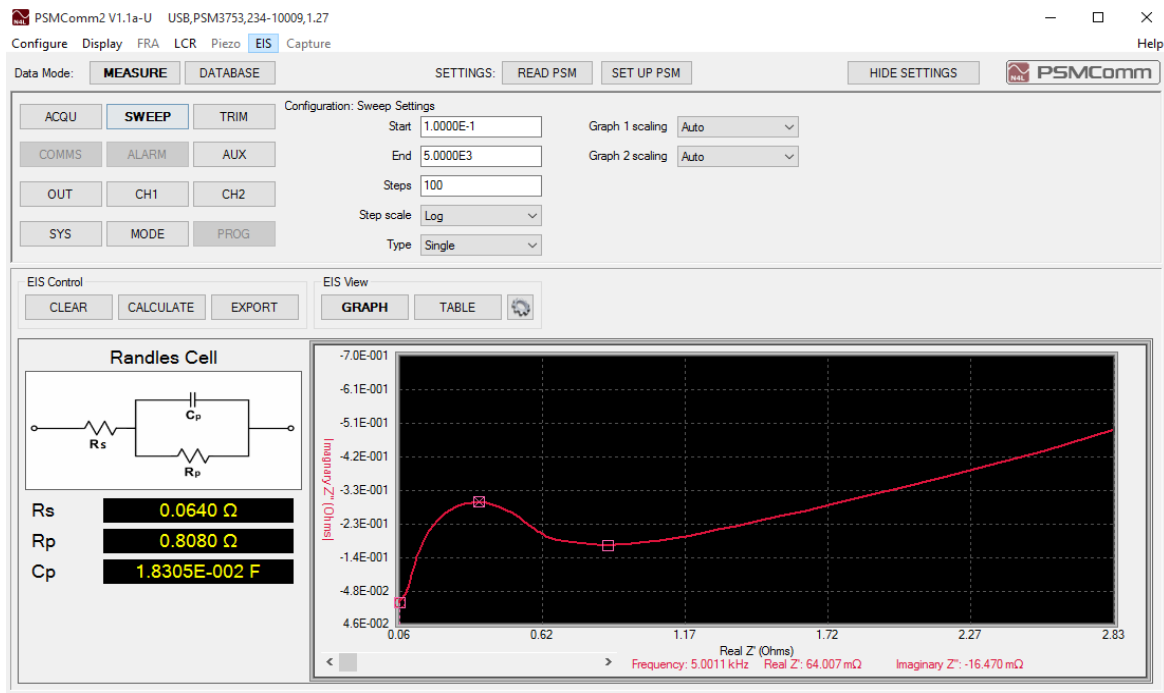

Fig 19. PSMComm EIS Mode

Results can also be directly exported to excel, communication to PSMComm2 is via USB, RS232 or LAN.

General Notes

The PSM3750 features galvanically isolated inputs and generator, with a bandwidth of 10uHz to 50MHz and a voltage rating of 500Vpk, the above test can be applied to a wide range of measurement applications.

References

- [1] Xi Zhang, Chris Mi, Vehicle Power Management, Control and Optimization, Springer 2011
- [2] E Barsoukov, J R Macdonald, Impedance Spectroscopy Theory, Experiment, and Applications, Wiley 2005.